



MINIFLEX LR

**ULTRASONIC LEVEL
MEASUREMENT**

LEVEL MEASUREMENT FOR LIQUIDS AND SOLIDS

MINIFLEX LR

Non-contact ultrasonic level measurement is one of the most versatile level measuring technologies available today but the introduction of the new MINIFLEX LR moves these boundaries even further into the next generation.

MINIFLEX LR with its wide range of transducers and advanced PULSE window echo tracking technology is capable of measuring virtually any liquid or solid and can be used in a wide range of industries from water and waste, to chemical and process, to quarry and aggregate.

The programming is via a simple five button keypad situated behind an IP65 protection front cover. The two line 16 digit display enables programming and configuration without the use of a manual by simply using a flow programming chart, reducing set-up time to a minimum.



APPLICATION FLEXIBILITY

LEVEL / DISTANCE / VOLUME

A measuring range of up to 10m makes this unit very versatile for a wide range of applications from small vessels to large process tanks; one unit suits many applications. The instrument can be configured to display in litres, gallons, tonnes, kg, m³ or %. From this display alarms and control relays can easily be programmed in real units. The multi-line display also provides an option for simultaneous display of both contents and ullage space if required.



When using MINIFLEX LR on open channel flow applications it is possible to display both the total flow and the instantaneous flow at the same time as well as displaying the units of measurement of the flow.

FLOW

BS3680 flume and weir configurations are provided as standard within the software together with 10 Parshall flumes. Instantaneous flow, total flow or head can be displayed. For non-standard flume applications an option for 24 point linearisation can be entered.

PUMP CONTROL

Flexibility for pump control is essential as every application can be different depending upon the nature of the product being pumped or the control philosophy required. MINIFLEX LR includes:

- Duty standby / assist** : for eliminating additional pump controls
- Alternating duty** : to even out wear of multiple pump installations
- Pump exerciser** : to periodically test pumps which have been lying idle for long periods
- Pump tolerancing** : to reduce fat build up in wet wells
- Pump run-on** : for de-sludging tanks
- Pump monitoring** : to record pump starts and run time
- Pump maintenance** : allows pump removal from sequence without re-programming

ALARMS

It is possible to program the 3 relays for a variety of applications including high and low alarms, stock re-order points, flow alarms and many other control functions.

DIFFERENTIAL CONTROL

MINIFLEX LR is capable of having two transducers input to one controller to enable the monitoring of an upstream and downstream level for control of lock gates and screen rakes.

SIMPLIFIED COMMISSIONING

With the aid of the simple flow diagram from Hycontrol the MINIFLEX LR is programmed in a fraction of the time compared to many instruments with similar capability. The program required is simply chosen through a menu structure and the parameters required are prompted along each step of the way. The parameters are entered via the 5 button keypad and no additional programmers are required. For additional security the keypad can also be password protected to stop any unauthorised changes to the program functions or set points.



Simple 5 button programming

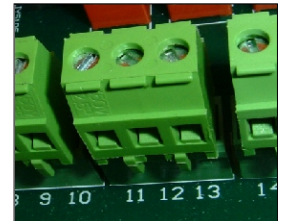

Quick two part connectors



Isolated electrical entry

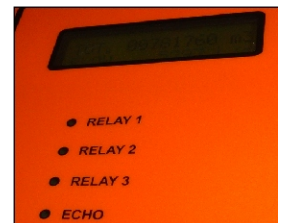

Clear indication of status



Simple electrical entries

ADVANTAGES OF MINIFLEX LR

- Non-contact ultrasonic technology with no moving parts providing long life and reliability
- Versatile technology for liquids, slurries, pastes and solids
- Maximum range of 10 metres (consult Hycontrol with application details on solids)
- Multi-programmable for wide range of applications including level, flow, differential and pump control
- Advanced echo extraction routine (PULSE) for stirrer and spurious signal avoidance
- Simple to install, commission and retrofit with a wide range of transducer options
- Dual supply voltage as standard - will accept AC or DC
- Hazardous area approval as standard option on flange and standard transducers
- Chemically resistant transducer materials for maximum application flexibility
- Clear display with enhanced 16 digit two line backlit LCD
- Five button programming with simplified commissioning via software flowchart
- Separate electrical terminals compartment to reduce risk of board damage when installing

APPLICATIONS FOR ALL INDUSTRIES



QUARRY



WATER & WASTE

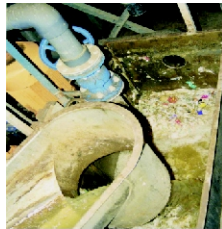

PROCESS



CHEMICAL



OFFSHORE

ADVANCED ECHO TRACKING CAPABILITY

Hycontrol has been designing and manufacturing ultrasonic level measuring systems for over thirty years and has developed patented echo tracking software capable of ignoring spurious echos which other manufacturers may detect.

PULSE (Proven Ultrasonic Level Signal Extraction) utilises a unique window technology which is able to distinguish between false and true echos and avoids obstacles such as ladders, crossbeams, stirrers and fill pipes. Difficult applications, including narrow tanks and wells with complicated internal structures can now be monitored with ease. This system includes well proven Automatic Gain Control (AGC) which enables the instrument to automatically adjust for different applications and return echos which constantly vary. MINIFLEX LR carries out this function without requiring any user interface.



The application shown (left) is on a clay slurry (slip) tank used in the manufacture of bathroom appliances. The manufacturer required a non-contact level measuring device which could not only measure the level but also ignore the very large stirrer rotating in the tank to keep the slurry fluid. The build up on the stirrer is very significant and provides a very large target for a false echo but PULSE window technology ignores this and only measures the correct level.

significant and provides a very large target for a false echo but PULSE window technology ignores this and only measures the correct level.

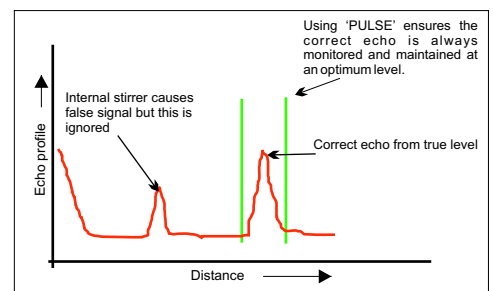

MINIFLEX LR

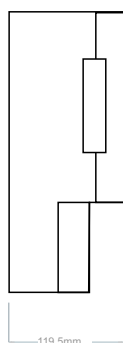
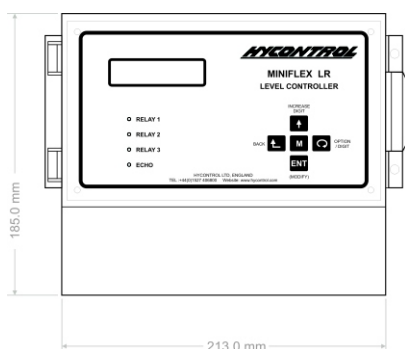

TRANSDUCERS

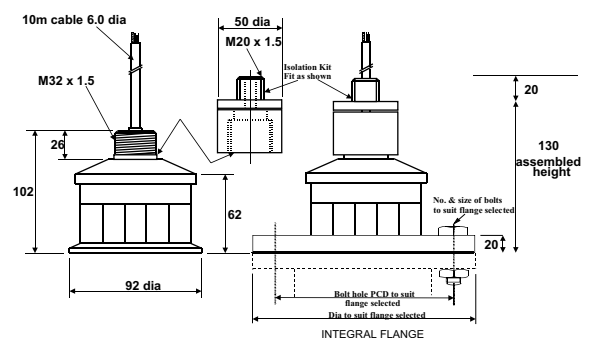

SPECIFICATION

PERFORMANCE SPECIFICATION

Measuring range	: Up to 10 metres on liquids and solids
Measuring mode	: Level, distance, differential, flow
Accuracy of change in level	: $\pm 0.25\%$ of measured distance from the transducer at constant temperature of 20°C
Resolution	: 2mm or 0.1% of range, whichever is the greater
Failsafe	: High, Low & Hold
Damping	: Fully adjustable 0-10 metres per minute
Blanking	: Fully adjustable, minimum 0.3 metres
Functions	: 7 standard tank shapes for volume conversion 10 Parshall flume curves BS3680 Flow laws + penstock control 24-point linearisation 7 separate pump control functions

HARDWARE SPECIFICATION

Power supply	: 95/110/230VAC $\pm 10\%$. 50/60Hz, 12VA 24VDC + 25%, -10%, 9W
Analogue output	: 4-20mA into 750 Ohms. 16 bit Short circuit protected and opto-isolated on ac powered unit
Relay Outputs	: 3 multi-function SPDT relays rated 8A/250VAC/30VDC resistive, with gold contacts for low power switching
Indication	: Integral display, 2 lines 16 digit alphanumeric backlit LCD 3 red LEDs to indicate relay status
Ambient temperature	: -20°C to +70°C for Miniflex LR enclosure
Interface	: 5 button keypad with security code
Temperature compensation	: Integral in transducers, or optional separate T-comp probe
Approvals	: KEMA 04 ATEX 1124X CE 0038 II 2 GD EExm II T6 @ 85°C CE approved - EMC tested in accordance with BS EN61000-6-2: 2001 BS EN61000-6-3 including A1 & C1 Low voltage directive, EN61010
Enclosure	: IP65, NEMA 4X, polycarbonate enclosure with hinged lid
Dimensions	: 185H X 213W X 119.5D (mm) - see diagram
Weight	: 1.55Kg

TRANSDUCERS

Model number	: RYTK15-ATEX	RWTK15	Rxxx15Fxx
Range	: 10 metres	10 metres	10 metres
Temperature compensation	: Yes	Yes	Yes
Frequency (in Khz)	: 41.5 kHz	41.5 kHz	41.5 kHz
Beam Angle at -3dB	: 12 degrees	12 degrees	12 degrees
Face Material	: Kynar	PVDF	PVDF
Process Temperature °C **	: -40 to +90	-40 to +90	-40 to +90
Protection	: IP68	IP68	IP68
Weight (Kg)	: 0.6	0.6	0.8-2.0
Mounting connection	: M20	M20	Flange*
Hazardous Area Approved	: Yes	Yes	Yes

* For flange options contact Hycontrol. Material to suit applications.

** -40°C to +60°C for ATEX

HYCONTROL LEVEL TECHNOLOGIES

Product Range For Solids :-

- (1) TDR Radar For Solids
- (2) Ultrasonic, 'Through Air'
- (2) 2 Wire Ultrasonic Transmitter
- (3) FMCW 2 Wire Radar
- (4) Continuous 'Servo' Level Indicator
- (5) FMCW 2 Wire Radar
- (6) Capacitance Level Switch
- (7) Vibrating Probe Level Switch
- (8) Rotating Paddle Level switch
- (9) Microwave Level Switch
- (10) Doppler Flow Switch

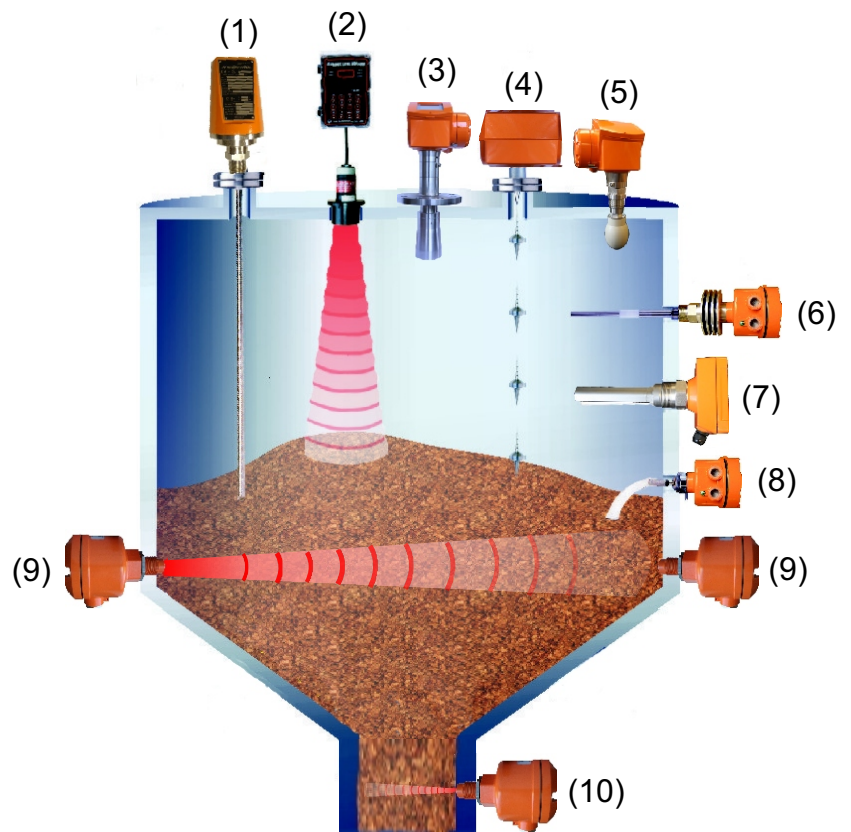

Product Range For Liquids :-

- (1) By-Pass Level Indicator With Radar
- (2) TDR Radar For Liquids
- (3) 2 Wire Ultrasonic Transmitter
- (4) FMCW 'Horn' Radar 2 Wire
- (5) Magnetic Float Switches
- (6) FMCW 2 Wire Radar
- (7) Capacitance Level Switch
- (8) RF Admittance Level Switch
- (9) Side Mounting 316 SS Float Switch
- (10) Tuning Fork Level Switch
- (11) Tuning Fork Level Switch
- (12) Ultrasonics 'Through Wall'
- (13) Mini Magnetic Float Level Switch

